



Leading Conversion Technology for Power Resilience

SIERRA 25 - 48/120

User Manual

THE NEW GENERATION OF POWER CONVERTERS

- **DUAL AC AND DC OUTPUT CONVERTER**
Commercial Power as default source
- **AC AND DC BACKUP IN A DC ENVIRONMENT**
Leverage your existing DC infrastructure
- **ONE STOP SHOP**
Wide output power range
- **HARSHEST AC INPUT CONDITIONS**
Without compromising the quality of the AC output



Copyright © 2024. Construction électroniques & telecommunications S.A.
All rights reserved. The contents in document are subject to change without notice.
The products presented are protected by several international patents and trademarks.
Address: CE+T S.a, Rue du Charbonnage 12, B 4020 Wandre, Belgium
www.cet-power.com - info@cet-power.com

Version 1.1

Contact us:  www.cet-power.com

Follow us on social media:



Table of Contents

1. CE+T Power at a glance.....	6
2. Abbreviations.....	7
3. Warranty and Safety Conditions	8
3.1 Disclaimer	8
3.2 Technical care	8
3.3 Installation	9
3.3.1 Handling.....	9
3.3.2 Surge and transients	10
3.3.3 Other.....	10
3.4 Maintenance	10
3.5 Replacement and Dismantling.....	10
4. ECI Technology.....	11
4.1 AC-AC mode.....	12
4.2 DC-AC mode	12
5. Building Blocks	13
5.1 Sierra 25 - 48/120	13
5.1.1 Specifications.....	13
5.1.2 Converter - LED Indications	15
5.2 Sub-rack.....	16
6. Monitoring device - Inview S, X and GW	17
7. Accessories	18
7.1 Cabinet	18
7.2 Manual By-Pass	18
7.3 AC Distribution Unit	18
7.3.1 Miniature Circuit Breakers	18
7.3.2 MCCB.....	19
8. System Design.....	20
8.1 A la Carte	20
9. Installation of Sierra 25 Shelf	21
9.1 Mounting kit for Sierra shelf	21
9.2 Electrical installation for Sierra shelf.....	22
9.2.1 Pre requisites	22
9.2.2 Terminations	23
9.2.3 Grounding	23
9.2.4 DC Connection	23
9.2.5 AC Input Connection	24
9.2.6 AC Output Connection	24
9.2.7 Signalling	24
9.2.8 Remote ON/OFF.....	25

9.2.9	Internal CAN BUS A and B.....	25
9.2.10	Shelf rear cover.....	26
10.	Installation of Cabinet	27
10.1	Unpacking the system.....	27
10.2	Module packing.....	27
10.3	Removing the cabinet rear protection	28
10.4	Hardware Connections	28
10.5	Electrical Installation	28
10.5.1	Positioning	29
10.5.2	Cabling.....	30
10.5.3	Grounding	30
10.5.4	Surge Suppression	30
10.5.5	AC Input (X2) and Output (X4)	31
10.5.6	DC (X1)	32
10.5.7	Connection table – DC 48 Vdc (X1)	32
10.5.8	Connection table – AC Input (X2) & Output (X4).....	33
10.5.9	Signalling	33
11.	Inserting/removing/replacing - modules.....	35
11.1	Sierra Converter	35
11.1.1	Removal.....	35
11.1.2	Inserting.....	35
11.2	Fan replacement	36
12.	AC Output Distribution.....	37
12.1	Miniature Circuit breaker Installation/Removal.....	37
12.2	MCCB.....	37
13.	Manual By-Pass (Optional)	38
13.1	Pre-requisites.....	38
13.2	MBP Auxiliary connection	38
13.3	Manual Bypass operation	39
13.3.1	MBP - Single rotary switch.....	40
13.3.2	MBP - Three individual switches.....	40
14.	Finishing	42
15.	Commissioning	43
15.1	Check list.....	44
16.	Trouble Shooting and Defective Situations Fixing.....	45
16.1	Trouble Shooting	45
16.2	Defective modules.....	46
17.	Maintenance.....	47
17.1	Access Inview with Laptop	47
17.2	Manual check.....	47
17.3	Optional	47
17.4	Manual By-Pass	47

18. Service	48
19. Appendix.....	49
19.1 Mains connection, Single phase	49
19.2 Mains connection, Three phases.....	50
19.3 Sierra 25 - Dimensions.....	51
19.3.1 Module.....	51
19.3.2 Shelf	51
19.4 Modules - Parameter List	52

Release Note:

Version	Release date (DD/MM/YYYY)	Modified page number	Modifications
1.0	05/05/2021	-	First release of the Manual
1.1	12/04/2024	-	Updated Inview Information

1. CE+T Power at a glance

CE+T Power is your trusted partner in **advanced power solutions** engineered to meet the demands of modern and dynamic industrial applications. With over 60 years of experience in power conversion technology, CE+T Power nurtures the industry with **innovative solutions designed for critical power backup and energy management**.

Our complete range of power solutions includes **modular inverters** (DC to AC), **UPS** (securing AC loads with batteries), and **multi-directional converters** (inverter, rectifier, and UPS all-in-one). Coupled with our state-of-the-art **monitoring solution**, you have a real energy blender to connect multiple sources of energy seamlessly!

Whether you require **robust backup power solutions**, **energy management solutions**, or a **combination of both**, CE+T Power delivers tailored solutions to meet your specific needs. Our products are **designed with integration in mind**, ensuring **seamless compatibility with other components of your system**. CE+T Power is committed to providing you with the expertise and resources needed to maximize the performance of your power systems.

Thank you for choosing CE+T Power as your partner in advanced power management. Let's power the future together.

2. Abbreviations

AC	Alternating current
CB	Circuit Breaker
DC	Direct current
DHCP	Dynamic Host Configuration Protocol
DSP	Digital Signal Processor
ECI	Enhanced Conversion Innovation
EMBS	External Maintenance Bypass Switch
EPC	Enhanced Power Conversion
ESD	Electro Static Discharge
ETH	Ethernet
G	Ground / Grounding
HTTP	HyperText Transfer Protocol
HTTPS	Secure HyperText Transfer Protocol
LAN	Local Access Network
MBB	Measure Box Battery
MBP	Manual By-pass
MCB	Miniature Circuit Breaker
MCCB	Molded Case Circuit Breaker
MET	Main Earth Terminal
MIB	Management Information Base
N	Neutral
NTP	Network Time Protocol
NUA	Non-Urgent Alarm
PCB	Printed Circuit Board
PE	Protective Earth (also called Main Protective Conductor)
PEK	Power Extension Kit
PPE	Personal Protective Equipment
PWR	Power
REG	Regular
SNMP	Simple Network Management Protocol
TCP/IP	Transmission Control Protocol/Internet Protocol
TRS	True Redundant Structure
UA	Urgent Alarm
USB	Universal Serial Bus

3. Warranty and Safety Conditions*

WARNING:

The electronics in the power supply system are designed for an indoor, clean environment.

When installed in a dusty and/or corrosive environment, indoor, it is important to:

- Install an appropriate filter on the enclosure door, or on the room's air conditioning system.
- Keep the enclosure door closed during operation.
- Replace the filters on a regular basis.

Important Safety Instructions, Save These Instructions.

3.1 Disclaimer

- The manufacturer declines all responsibilities if equipment is not installed, used or operated according to the instructions herein by skilled technicians according to local regulations.
- Warranty does not apply if the product is not installed, used or handled according to the instructions in the manual.
- This equipment is shipped with a SHOCKWATCH monitor. If the SHOCKWATCH shows that the equipment was exposed to excessive force the warranty will be void.

3.2 Technical care

- This electric equipment can only be repaired or maintained by a “qualified employee” with adequate training. Even personnel who are in charge of simple repairs or maintenance are required to have knowledge or experience related to electrical maintenance.
- Please follow the procedures contained in this Manual, and note all the “DANGER”, “WARNING” AND “NOTICE” marks contained in this Manual. Warning labels must not be removed.
- Qualified employees are trained to recognize and avoid any dangers that might be present when working on or near exposed electrical parts.
- Qualified employees know how to lock out and tag out machines so the machines will not accidentally be turned on and injure employees working on them.
- Qualified employees also know safety related work practices, including those by OSHA and NFPA, as well as knowing what personal protective equipment should be worn.
- All operators are to be trained to perform the emergency shut-down procedure.
- Never wear metallic objects such as rings, watches, or bracelets during installation, service and maintenance of the product.
- Insulated tools must be used at all times when working with live systems.
- When handling the system/units pay attention to sharp edges.
- This product is suitable for use in a computer room.

* These instructions are valid for most CE+T Products/Systems. Some points might however not be valid for the product described in this manual.

3.3 Installation

- This product is intended to be installed only in restricted access areas as defined by local regulations and in accordance with the National Electric Code, ANSI/NFPA 70, or equivalent agencies.
- The Converter System may contain output over current protection in the form of circuit breakers. In addition to these circuit breakers, the user must observe the recommended upstream and downstream circuit breaker requirements as defined in this manual.
- Please use extreme caution when accessing circuits that may be at hazardous voltages or energy levels.
- The modular converter rack is a dual input power supply. The complete system shall be wired in a way that both input and output leads can be de-energized when necessary.
- The systems that have no AC input wired and connected can be seen as independent power sources. To comply with local and international safety standards N (input) and PE shall be bonded. The bonded connection between N (input) and PE must be removed once the AC input is connected.
- AC and DC circuits shall be terminated with no voltage / power applied (de-energized).
- The safety standard IEC/EN62040-1-1 requires that, in the event of an output short circuit, the converter must disconnect in 5 seconds maximum. The parameter can be adjusted on Inview; however, if the parameter is set at a value > 5 seconds, an external protection must be provided so that the short circuit protection operates within 5 seconds. Default setting is 60 seconds.
- The system is designed for installation within an IP20 environment. When installed in a dusty or humid environment, appropriate measures (air filtering) must be taken.
- Environment Conditions:
 - Storage Conditions: -40 to 70°C
 - Relative Humidity: 95%, non-condensing
 - Altitude above sea without de-rating: Less than 1500 m
Greater than 1500 m – de-rating at 0.8% per 100 m
Should not be installed above 4000 m
- All illustrations in the manual are for general reference, refer to the technical drawing which is received along with the system for exact information.

3.3.1 Handling

- The cabinet shall not be lifted using lifting eyes.
- Remove weight from the cabinet by unplugging the converters. Mark converters clearly with shelf and position for correct rebuild. This is especially important in dual or three phase configurations.
- Empty converter positions must not be left open. Replace with module or blank cover.

3.3.2 Surge and transients

The mains (AC) supply of the modular converter system shall be fitted with Lightning surge suppression and Transient voltage surge suppression suitable for the application at hand. Manufacturer's recommendations of installation shall be adhered to. Selecting a device with an alarm relay for function failure is advised.

Indoor sites are considered to have a working lightning surge suppression device in service.

- Indoor sites Min Class II.
- Outdoor sites Min Class I + Class II or combined Class I+II. The modular converter system/rack can reach hazardous leakage currents. Grounding must be carried out prior to energizing the system. Grounding shall be made according to local regulations.

Note:

Choosing and installing surge arrestors must obey to precise technical rules. Distance to equipment to protect, cable gage and cable routing have significant influence on proper device service.

Some areas are more susceptible to be hit by electrical strikes, especially when altitude increases.

Good earthing is also crucial for surge arrestors to work properly.

CE+T declines any liability in regard to damaged caused to equipment not correctly or not sufficiently protected.

3.3.3 Other

- Insulation test (Hi-Pot) must not be performed without instructions from the manufacturer.

3.4 Maintenance

- The converter system/rack can reach hazardous leakage currents. Earthing must be carried out prior to energizing the system. Earthing shall be made according to local regulations.
- Prior to any work conducted to a system/unit, make sure that AC input voltage and DC input voltage are disconnected.
- Prior to accessing the system or modules, make sure all source of supply is disconnected.
CAUTION – Risk of electric shock. Capacitors store hazardous energy. Do not remove cover until 5 minutes after disconnecting all sources of supply.
- Some components and terminals carry high voltage during operation. Contact may result in fatal injury.

3.5 Replacement and Dismantling

- ESD Strap must be worn when handling PCB's and open units.
- The converter system/rack is not supplied with internal disconnect devices on input nor output.
- CE+T cannot be held responsible for disposal of the converter system and therefore the customer must segregate and dispose of the materials which are potentially harmful to the environment, in accordance with the local regulations in force in the country of installation.
- If the equipment is dismantled, to dispose of its component products, you must comply with the local regulations in force in the country of destination and in any case avoid causing any kind of pollution.

To download the latest documentation and software, please visit our website at www.cet-power.com

4. ECI Technology¹

A Sierra module is a triple port converter built with ECI technology. This module delivers pure sinusoidal output and ripple free DC output from AC mains or battery.

The below block diagram gives an explicit description of the topology and its operation.

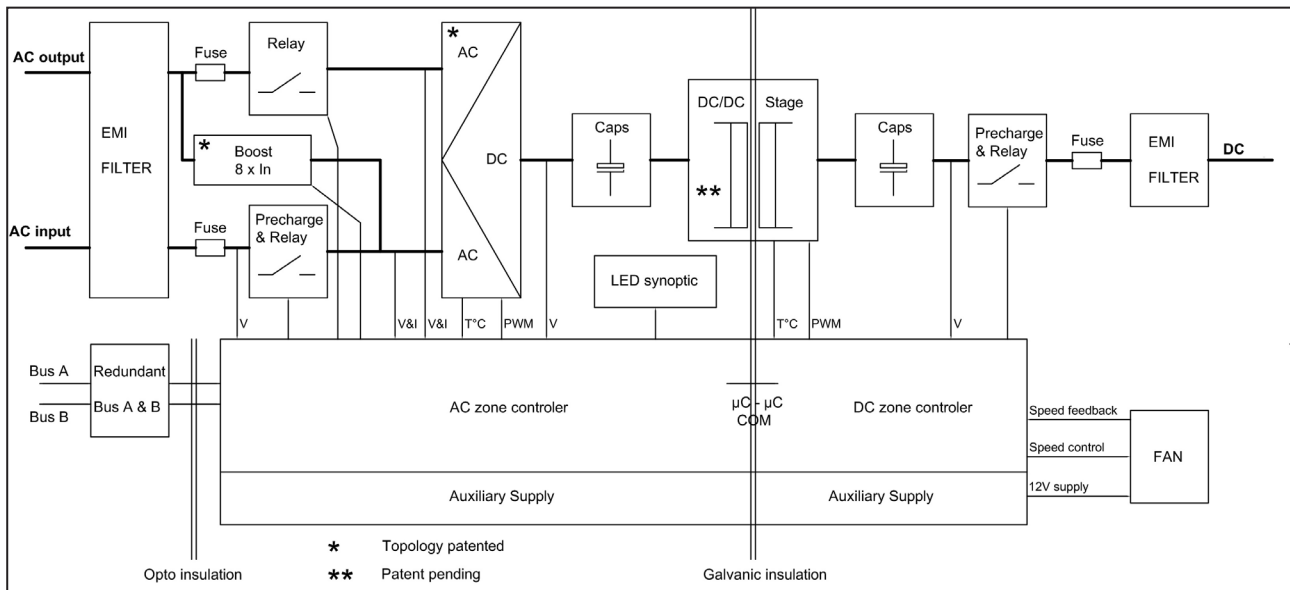

ECI technology has AC to DC, DC to AC, and DC to DC converters to provide constant and disturbance-free output power regardless of the input source.

The power flows either from AC or DC source under the control of the DSP controller. Thanks to the module's internal energy buffering, transferring the load between two input sources is achieved in 0 ms.

ECI can detect short circuit conditions at the AC output level and start the BOOST mode function. This mode will provide 8x of the nominal current to clear the fault within 20 ms, and thus keeping other critical loads in operation.

Sierra module works on True Redundant Structure (TRS) that features decentralized, independent logic, and redundant communication bus.

Each Sierra module has three levels of protection, and it will help to isolate from other modules in case of any fault in the corresponding module. Due to this functionality in each module, it provides no single point of failure in modular systems.

The Sierra modular systems provide quality output power with higher efficiency.

¹ Information and data given in this chapter is intended to serve as an overview of the ECI Technology. Detailed features and parameters for each individual module type in the range may differ and should be referred to in the dedicated data sheet.

4.1 AC-AC mode

In AC-AC mode, the AC Mains is the primary source and DC source works as a backup. When AC mains is present, the Sierra module takes energy from the AC source and feed to:

- AC Load via a double conversion to provide a pure sine wave.
- DC load and also charges the battery with a regulated DC.

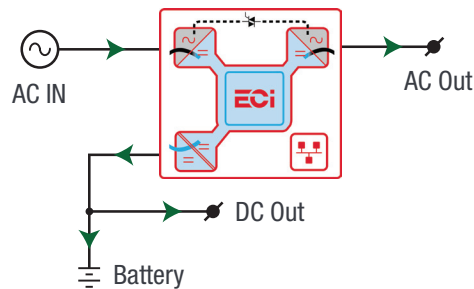

The total output power of a module can be shared between the AC load, DC load and charging power based upon the requirement.

If the AC source is not present, the module seamlessly switches to DC source without impacting the critical loads and resumes to EPC mode once AC source returns. The transfer time between AC to DC and DC to AC is 0 ms.

The EPC mode provides a higher efficiency of $\geq 96\%$ without compromising the purity of the output sine wave.

4.2 DC-AC mode

In DC-AC mode, module operates in DC source and feed to:

- AC Load via a double conversion to provide a pure sine wave.
- DC load directly.
- Measure Box Battery (MBB) is used for DC power calculation.

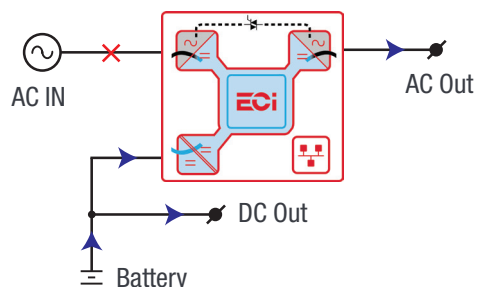

5. Building Blocks

5.1 Sierra 25 - 48/120

Telecom / Datacom:	Input	48 Vdc 120 Vac, 50/60 Hz
	Output	48 Vdc 120 Vac
	Power	2.75 kVA / 2.25 kW



- The Sierra converter is a triple port converter.
- Each converter can supply 2.25 kW on any DC, AC or combination of both AC and DC output ports. AC output load is the highest priority. Even if AC output is fully loaded (2.25 kW), still 300 W is available for DC output.
- Hot swappable and hot pluggable.
- The front LED's indicate the converter status and output power.
- The module is equipped with soft start.
- The modules' fan is field replaceable.
- 435 mm (D) x 102 mm (W) x 88 mm (H).
- 5 Kg.

5.1.1 Specifications

Model	Sierra 25 - 48/120
Part Number: Module / shelf	T721330201 / T724330000
Cooling / Audible noise	Fan forced cooling / <65db @1meter
MTBF	240 000 hrs (MIL-217IF)
Dielectric strength DC/AC	4300 Vdc
RoHS	Compliant
Operating T° / Relative Humidity (RH) non-condensing	Tested according ETS300-019-2-3 Class 3.1 -20°C to 65°C, power de-rating from 40°C to 65°C / Max RH 95% for 96 hours per year
Storage T° / Relative Humidity (RH) non-condensing	Tested according ETS300-019-2-1 Class 1.2 -40°C to 70°C / Max RH 95% for 96 hours per year
Public transport T°/Relative Humidity (RH) non-condensing	Tested according ETS300-019-2-2 Class 3.1 -40°C to 70°C / Max RH 95% for 96 hours per year
Material (casing)	Zinc coated steel
AC Input Data	
Nominal voltage	120 Vac
Voltage range	90 - 140 Vac

Model	Sierra 25 - 48/120
Brownout	1600 W @ 90 Vac / 2550 W @ 100 Vac linear decreasing
Power factor	> 0.99
Frequency (Synchronization range)	50 Hz (47 – 53 Hz) / 60 Hz (57 – 63 Hz)
DC Input Data	
Nominal voltage / range	48 Vdc / 40-60 V
Nominal current	52.3 A @ 48 Vdc & 2.25 kW
Maximum input current (for 15 seconds) / voltage ripple	63 A / < 10 mVRMS
AC Output Data	
Efficiency AC to AC (EPC) / DC to AC / AC to DC	94.5% / > 92.5% / > 92.5%
Nominal voltage (Adjustable)	120 V (100 - 130 Vac)
Frequency / frequency accuracy	50 or 60 Hz / 0.03%
Nominal Output power	2.75 kVA / 2.25 kW @ 48 Vdc
Short time overload capacity	125% (15 seconds)
Admissible load power factor	Full power rating from 0 inductive to 0 capacitive
Total harmonic distortion (resistive load)	< 3%
Load impact recovery time (10% - 90%)	≤ 0.4 ms
Nominal current	22.9 A @ 48 Vdc
Crest factor at nominal power	3 : 1 for load P.F. ≤ 0.7
Short circuit clear up capacity 0 - 20 ms	167.7 A (peak) and 116.4 A (rms) on AC / 88.8 A (peak) and 58.9 A (rms) on DC
Short circuit current after >20 ms -15 sec / 15 sec - 1 min	45.5 A (peak) and 36 A (rms) / 38.6 A (peak) and 30 A (rms)
AC output voltage stability	±1% from 10% to 100% load
DC Output Data	
Nominal Voltage / range	53.5 Vdc / 40-61 V
Maximum power	2.25 kW
Maximum current	46.8 A @ 48 Vdc
Reverse polarity protection	Yes
Efficiency AC to DC	> 92.5%
In Transfer Performance	
Max. Voltage interruption / total transient voltage duration (max)	0 sec / 0 sec

Model	Sierra 25 - 48/120
Signalling & Supervision	
Display	Synoptic LED
Supervision / Part number	Inview S / T602004100, Inview X / T602004200 and Inview GW / T602004000
Remote on / off	On rear terminal of the shelf
Battery Monitoring / Part number	MBB (Measure Box Battery) / P602006000
Safety & EMC	
Safety	cUL recognized according UL1778
EMC	EN 61000-4-2 / EN 61000-4-3 / EN 61000-4-4 / EN 61000-4-5 / EN 61000-4-6 / EN 61000-4-8 ETSI EN 300386 v1.9.1 / FCCpart 15 class A

5.1.2 Converter - LED Indications

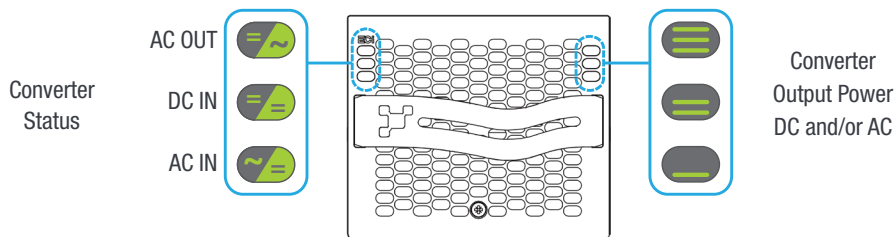

Converter Status LED	Description	Remedial action
OFF	No input power or forced stop	Check environment
Permanent green	Operation	
Blinking green	Converter OK but working conditions are not fulfilled to operate properly	
Blinking green/orange alternatively	Recovery mode after boost (10 In short circuit condition)	
Permanent orange	Starting mode	
Blinking orange	Modules cannot start	Check Inview
Blinking red	Recoverable fault	
Permanent red	Non recoverable fault	Send module back for repair

Output Power (redundancy not counted)						
<5%	5% to 40%	40 to 70%	80 to 95%	100%	100% = overload	Output Power (redundancy not counted)
×	×	×	≡	≡	≡	Status output power LED
×	×	≡	≡	≡	≡	
—	—	—	×	—	—	
1B	1P	2P	2P	3P	3B	Behaviour (B - Blinking, P - Permanent)

5.2 Sub-rack

- The Sierra shelf shall be integrated in min 600 mm deep cabinets, Inch/ETSI mounting.
- The Sierra shelf houses max four (4) converter modules.
- The Sierra shelf is designed with individual DC input / output, Common AC input and Common AC output.
- Optional rear cover for IP 20 in open rack.
- Max 12 kVA per shelf.
- 480 mm (D) x 19" (W) x 2U (H).
- 6 Kg (without modules).



6. Monitoring device - Inview S, X and GW

Sierra 25 modules can be monitored through Inview S, X or Inview GW. For more details about these monitoring devices and the hardware connections, refer to the Inview and Inview GW user manuals.

Inview S and X - <https://datasheet.cet-power.com/CET - Monitoring - User Manual - Inview - EN.pdf>

Inview GW - <https://datasheet.cet-power.com/CET - Monitoring - User Manual - Inview GW - EN.pdf>



Inview GW



Inview S



Inview X

7. Accessories

7.1 Cabinet

Powder coated, Rittal and Metrobit cabinet with 600 x 800 mm foot print.

- Rittal: 2000 (H) x 800(D) x 600(W) mm
- Metrobit: 583(H) x 800(D) x 600(W) mm

The cabinet comes with a separable top cover to facilitate cabling. Tie strap support at cable entrance/exit.

Door accessory is optional.

7.2 Manual By-Pass

The manual by pass operates via manually operated switches to create a short circuit from the AC main input directly to the output AC distribution. Standard manual by-pass is “Make before Break”. When engaged or disengaged, no disturbance is transmitted to the load.

When MBP is engaged, inverter modules are switched off and can be removed without impacting the load. The battery supply is not physically disconnected. After disconnecting the battery supply (by opening the battery breakers), the shelf section is safe for maintenance.

Warning: When the system is in by-pass, the load is subjected to AC main disturbances. Before engaging manual bypass, make sure the voltage difference between AC IN and AC OUT should be less than 5 Vac to limit the inrush current.

7.3 AC Distribution Unit

7.3.1 Miniature Circuit Breakers

The standard AC output distribution unit is designed with a 35 mm DIN rail, Multi Clip termination board and N/PE copper terminal bars, and built as a part of the cabinet.

The Multi Clip offers unique flexibility during installation and expansion. The terminals are spring loaded and adapt contact pressure to the size of conductor. Only one cable can be inserted per spring loaded terminal.

The AC distribution unit is available with 1 pole, 2 pole or 3 poles.

Max current per AC DU is 200 A, max current per terminal connector is 40 A. Two adjacent terminal connectors shall be used for 63 A breakers.

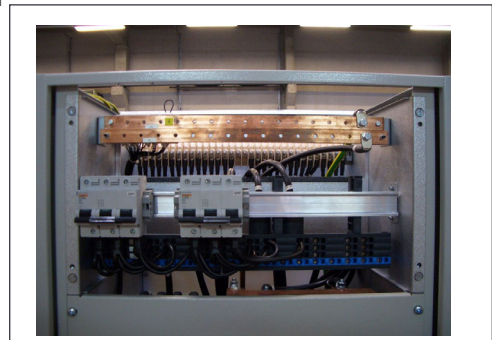

If an alarm is required for AC output breakers, a help contact attached to each individual breaker is used (OF or SD). The alarm function is common and uses one of the digital inputs on the control unit. The help contact limits the breakers quantity.

	Single pole		Double pole		Three pole	
	w/o help contact	With help contact OF/SD	w/o help contact	With help contact OF/SD	w/o help contact	With help contact OF/SD
Up to 40A	24	16	12	9	8	6

7.3.2 MCCB



AC output distribution via MCCB in the range up to 400 A (1p, 2p or 3p).

Max two MCCB per inverter cabinet.

8. System Design

8.1 A la Carte

The A la Carte is pre-assembled and configured as a single phase or three phase system. The system comprises cabinet, converter sub rack, converter modules (48, 110 & 380 Vdc), manual by-pass, monitor device and output distributions.

Single phase system accommodates **1 to 32** modules and provides maximum **88 kVA**.

Three phase system accommodates **3 to 30** modules and provides maximum **82.5 kVA**. By using PEK, the system can parallel up to **1237 kVA**.

Sierra system featured with:

- Dual input (AC & DC)
- Dual output for AC and DC loads
- More than 94.5% efficiency during normal operation (EPC)
- Pure sinusoidal AC output and ripple free DC output
- Seamless transfer (0 ms) between primary and secondary source of supply
- No single point of failure
- Flexible output distribution
- True modularity, redundancy and hot-swappable

Optional

- Manual by-pass
- AC output distribution
- DC distribution
- Battery fuses
- Battery LVD
- Surge arresters
- Door



9. Installation of Sierra 25 Shelf

- Read safety instructions prior starting any work.
- Do not attempt to use lifting eyes to erect the cabinet.
- System is preferable handled without modules.
- Pay attention to the module position, make sure that modules are repositioned in the same slot.
- In three phase systems, the modules are configured as per phase 1 (A, R), phase 2 (B, S) and phase 3 (C, T). As long as the system is not in operation, make sure that modules from one phase are not mixed with modules from another phase.
(When the system is running, modules can be moved from one phase to another without issue.)

9.1 Mounting kit for Sierra shelf

The fixing brackets, together with the sliders, allow for different cabinet depths.

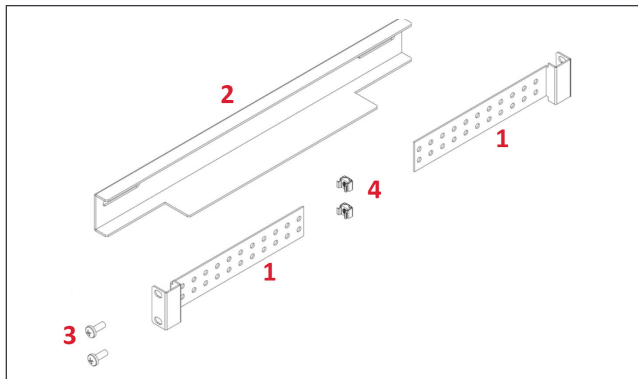

- 1** → Fixing brackets - 4 Nos
- 2** → Slider - 2 Nos
- 3** → Mounting screws - 12 Nos
- 4** → Cage nuts - 12 Nos

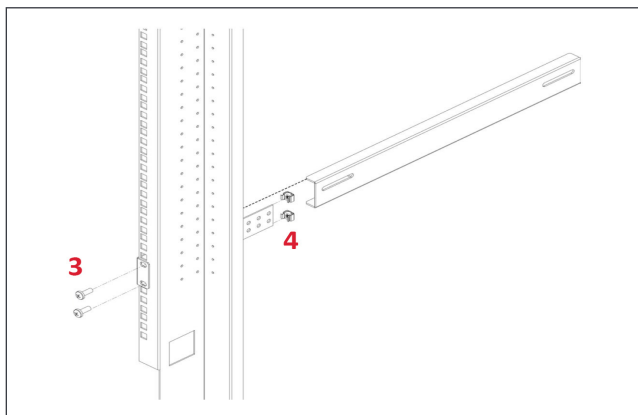

Assemble the sliders and adjust the length to suit the mounting depth.

Fix cage nuts (**4**) in the cabinet front and rear frame of the left and the right side.

Fix the left and right slider of the cabinet with the supplied screws (**3**).

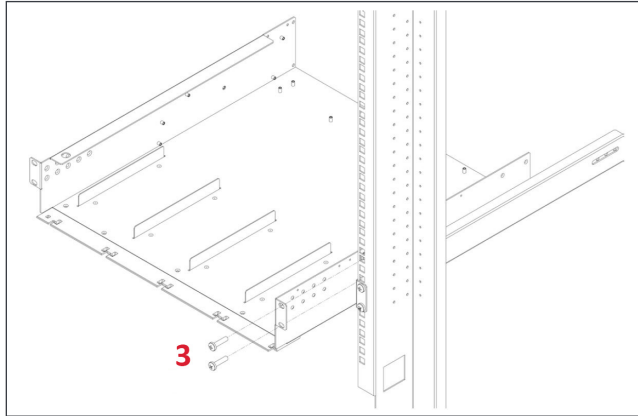

Fix cage nuts (4) in the mounting frame.

Slide the shelf in position and fix the shelf with the supplied screws (3).

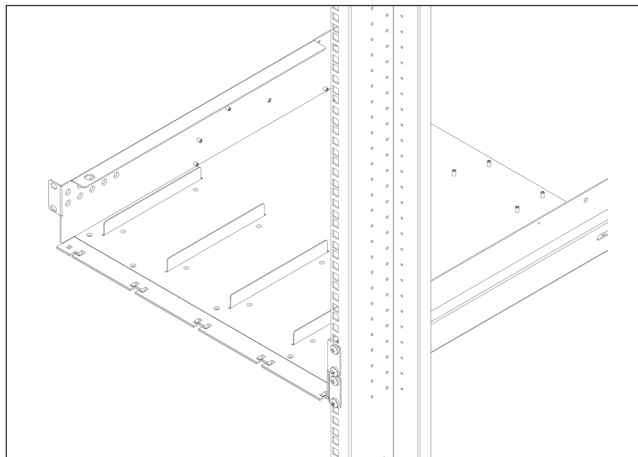

Finished.

9.2 Electrical installation for Sierra shelf

9.2.1 Pre requisites

- The sub-rack have markings for all terminations.
- All cables shall be rated at Min 90 deg C.
- Electrical terminations shall be tightened with 5Nm.
- All connection screws are M5 x 12 mm.
- DC Input-Individual (per module), observe polarity.
- AC Input / AC output-Common (per shelf), respect phases.
- Wire all positions in the sub-rack for future expansion.
- Input AC / Output AC / Input DC / Signal cables shall be separated.
- Cable crossings shall be done in 90 deg angles.

9.2.2 Terminations

The below image is termination details of Sierra 25 - 48/120 shelf.

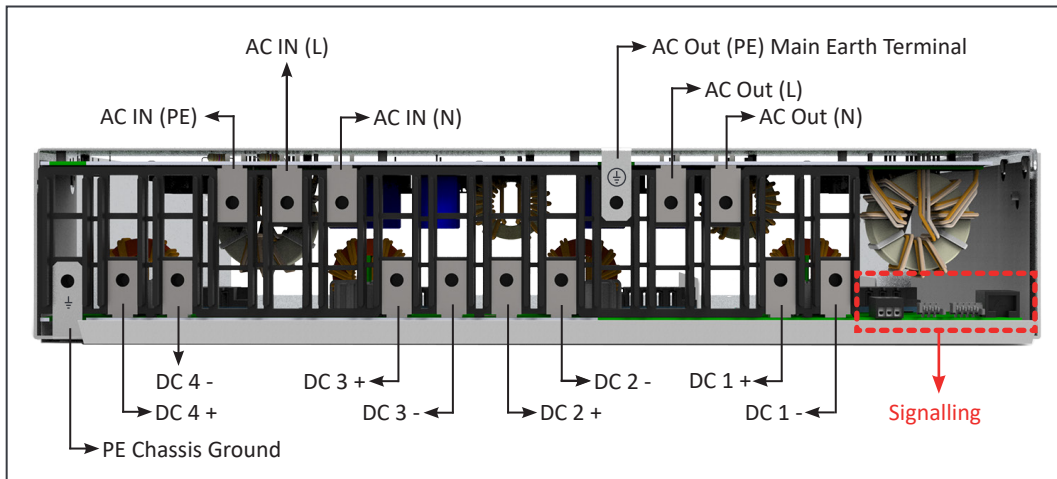

Sierra 25 - 48/120 - Shelf Rear Details

9.2.3 Grounding

“PE CHASSIS GROUND” 

PE Chassis ground shall be wired to MET or distributed earth bar connected to MET, according to local regulations.

Warning:

The converter module and shelves contain filters designed to protect against voltage surges and other disruptions. These filters have capacitors between L, N and earth (PE), which adds to the overall capacitance of the wiring system and the overall level of leakage current. Operation in the IT network may conduct to a high leakage current that needs to be monitored and controlled.

9.2.4 DC Connection

Model	MCB per converter module	Cable, min	Connector	Torque
Sierra 25 - 48/120	63 A	2 x 16 mm ²	M5	5 Nm

9.2.5 AC Input Connection

WARNING !!!

Recommendation of IEC 60364 4. 43

431.3 Disconnection and reconnection of the neutral conductor in multi-phase systems

Where disconnection of the neutral conductor is required, disconnection and reconnection shall be such that the neutral conductor shall not be disconnected before the line conductors and shall be reconnected at the same time as or before the line conductors.

RCD Recommendation

This equipment contains EMI/EMC filter, which generates a leakage current below 3.5 mA per converter in conformity with UL1778 safety standard. If an RCD device needs to be installed, it should be placed at the AC output of the equipment.

Model	CB per shelf	Cable, min	Connector	Torque
Sierra 25 - 48/120	2p 100A	3 x 4 AWG (2 x 16 mm ²)	M5	5 Nm

Note: Icc value measured as 140 A_{rms} per shelf with four modules.

9.2.6 AC Output Connection

Model	MCB per shelf	Cable, min	Connector	Torque
Sierra 25 - 48/120	2P 100 A	3 x 4 AWG (2 x 16 mm ²)	M5	5 Nm

9.2.7 Signalling

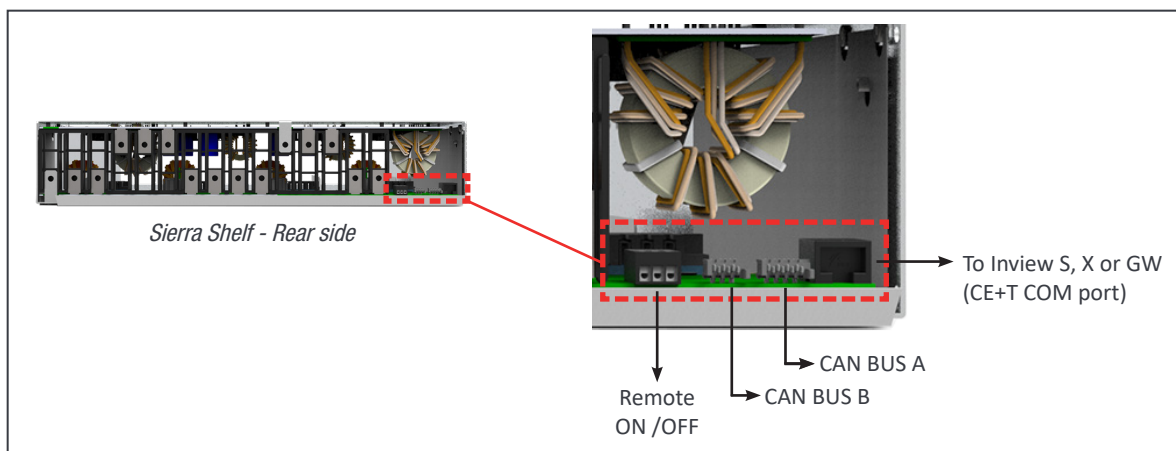

9.2.8 Remote ON/OFF

The function of remote ON/OFF is used turn off the module/system output.

By default a jumper is placed between pin 3 and 2. If remote on/off is used, jumper should be removed from the shelf and connect changeover contactor.

- AC and DC inputs are not affected by the remote ON/OFF function.
- The remote ON/OFF can be connected to any shelf.
- The remote ON/OFF requires changeover contactor, one input opens as the other close. If both transitions are not picked up the status is not changed.

Relay characteristics (Remote ON/OFF)

- Signal voltage +5 VDC (galvanic insulated)
- Max wire size 1 mm²

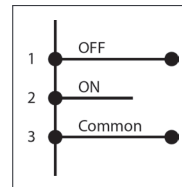

Functional table for remote ON/OFF function

#	Pin 1-3	Pin 2-3	Status	Indication
1	Open	Open	Normal operation	All (Green)
2	Closed	Open	OFF	AC output (OFF) AC Input (Green) DC Input (Green)
3	Open	Closed	Normal operation	All (Green)
4	Closed	Closed	Normal operation	All (Green)

Warning: If remote ON/OFF is not used, pin 2 and 3 MUST be bridged together!

9.2.9 Internal CAN BUS A and B

- In A la Carte systems the internal Bus is pre installed.
- The internal bus comprises 6 and 8 pin ribbon cables.
- The internal bus connectors are sensitive and special caution should be taken during installation to keep them out of harms way.
- The internal bus is connected from the first shelf to the last shelf.

9.2.10 Shelf rear cover

The rear cover provides IP20 protection for the terminations at the backside of the shelf. It is optional and can be ordered separately.

- The rear cover is snapped into position in the rear of the sub-rack.
- Remove material using a pair of side-cutters to allow cable entry and exit.

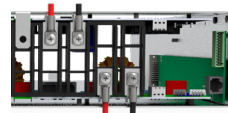

Connect the cables.

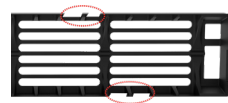

Cut appropriate size on the protection cover for cable access.



Fix the protection cover at rear side of the shelf.

10. Installation of Cabinet

10.1 Unpacking the system

CE+T cabinets are always fixed on a pallet, and then packed in a wooden crate.

These crates are usually delivered laying flat, horizontally.

To unpack your cabinet, we recommend the following method:

1. Make sure that the crate is laying flat, with the correct side up. This side is identified by a double red arrow.
2. Remove the top cover in order to be able to identify the top and bottom sides of the cabinet.
3. Raise the crate vertically with the top side of the cabinet up. Make sure that the cabinet does not fall forward out of the crate while you do so.
4. Remove the cabinet and its attached pallet from the crate.

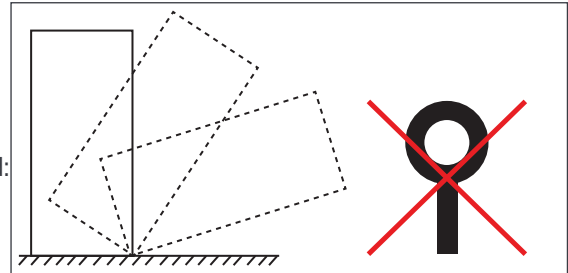

If you prefer to take the wooden crate apart before raising the cabinet, make sure you do not damage or dent the cabinet while doing so.

Warning: The top cover fixing bolts may NEVER be replaced with lifting eye bolts.

10.2 Module packing

When converters are ordered **together with a system**, they are either delivered in the cabinet or on a separate pallet.

- If you find the converters in the cabinet: you need to remove them in order to raise the cabinet more easily, but **before you do so make sure to have identified in which slot was each module. Indeed, it is important to replace each module in the same slot** it was delivered in!
- If the modules have been delivered separately, in carton on pallet, they will be clearly identified in order to be placed in the right slot.
- It is important to place the modules in the right slot, as this will ensure that the addressing of each module in the config file corresponds to the physical slot. Without this, the system will of course function properly but you might find it difficult to identify on which modules your applying changes you would be bringing to the config file.
- Also, in 3 phase systems, replacing modules configured to function in a specific phase in a slot assigned to another phase will result in the module to be un-synchronized. Your system may not start and you will have to reconfigure manually each module that was misplaced.

If you ordered modules only:

- If they are meant to be used in running systems or in a not operational single phase system, you may insert them in any slot.
- If they are meant to be placed in a not yet started 3 Phase system, follow these steps:
 - Insert one module per phase.
 - Start the system according to the start-up and commissioning procedure.
 - Insert the remaining modules progressively.

Module packing material shall be taken apart.

10.3 Removing the cabinet rear protection

Wooden wedges are fixed at the back of the cabinet to prevent parts from moving and sustaining damage during transportation. These wooden wedges must be removed before going further with the cabinet's installation and commissioning.

1. Remove the rear panel.
2. Identify the protection (see the following figure).
3. Cut the tie wraps holding the back wedges and remove them.

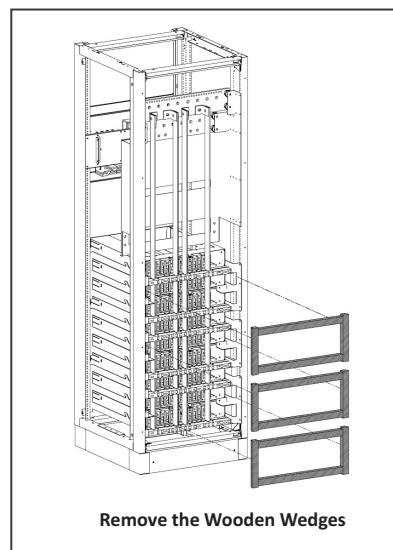
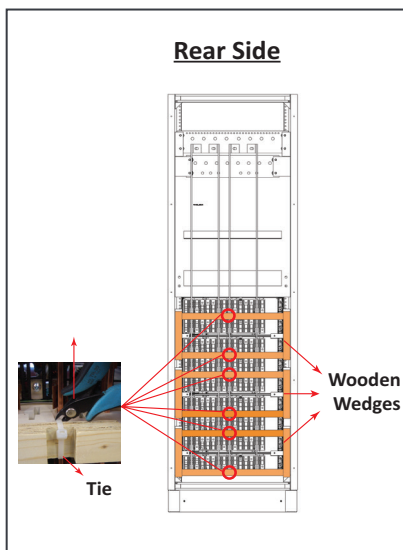

10.4 Hardware Connections

Refer to the Inview User Manual for hardware connections between a Sierra shelf, an Inview controller and an optional Measure Box Battery.

10.5 Electrical Installation

- All cables shall be halogen free and rated min 90 deg C.
- Wire all positions for future expansion.
- Input AC / Output AC / Input DC / Signal cables shall be separated.
- Cable crossings shall be made at 90 deg angles.
- Empty module positions shall be covered with blank or dummy module.

10.5.1 Positioning

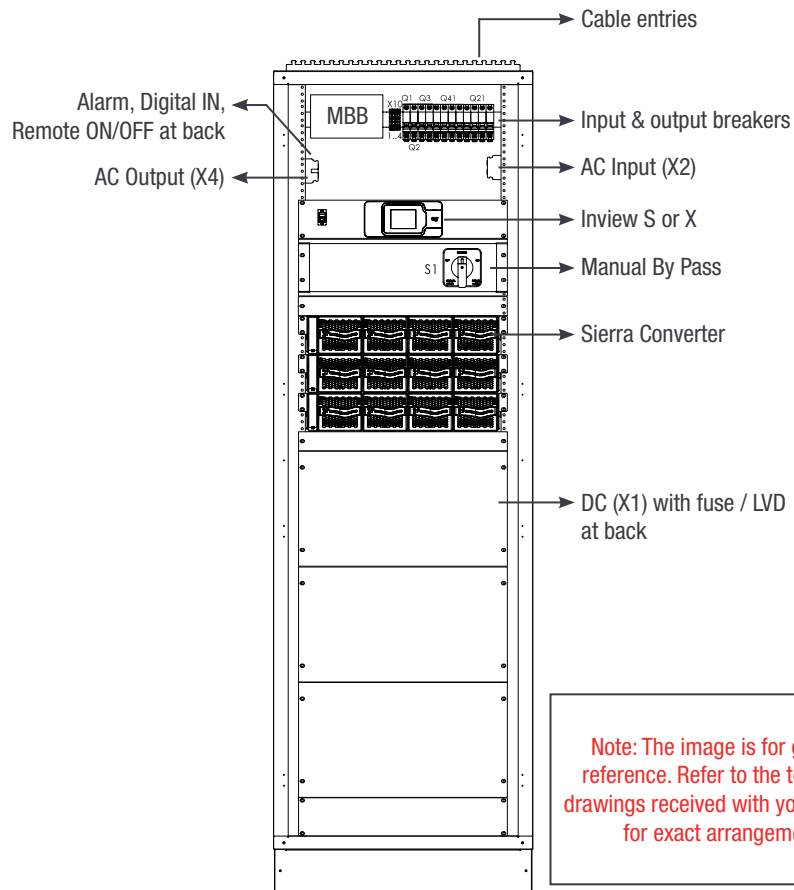

10.5.2 Cabling

All the cable routings are made through top or bottom of the system. The top cover can be split into two parts to facilitate cabling. The top cover accommodates nylon tie straps used to strap the cables.

Note: Do not block the airflow at top of the cabinet.

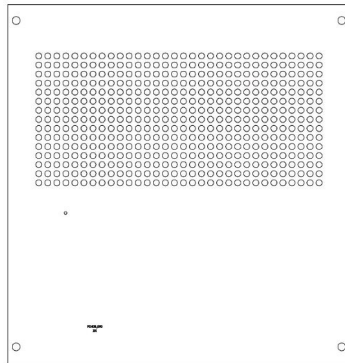

Top plate - Type I

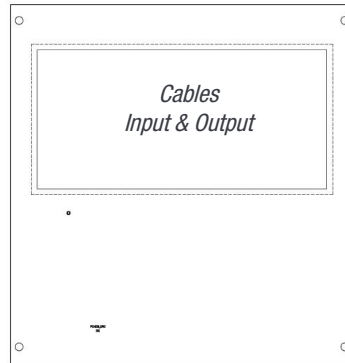

Top plate - Type II

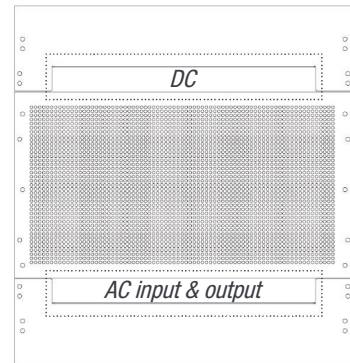

Top plate - Type III

10.5.3 Grounding

Ground terminals are located in the top rear left corner, labelled “PE CHASSIS GROUND” 

PE Chassis ground shall be wired to MET or distributed earth bar (MET). Ground must be terminated even if commercial mains is not available.

According to local regulations, Min 16 mm².

Warning:

The converter module and shelves contain filters designed to protect against voltage surges and other disruptions. These filters have capacitors between L, N and earth (PE), which adds to the overall capacitance of the wiring system and the overall level of leakage current. Operation in the IT network may conduct to a high leakage current that needs to be monitored and controlled.

10.5.4 Surge Suppression

The mains (AC) supply of the modular converter system shall be fitted with suitable Lightning surge suppression and Transient voltage surge suppression for the application at hand. Manufacturer’s recommendations of installation shall be adhered. It is advisory to select device with alarm relay for function failure.

Indoor sites are considered to have a working lightning surge suppression device in service.

- Indoor sites Min Class II.
- Outdoor sites : Min Class I + Class II or combined Class I+II.

10.5.5 AC Input (X2) and Output (X4)

WARNING !!!

Recommendation of IEC 60364 4. 43

431.3 Disconnection and reconnection of the neutral conductor in multi-phase systems

Where disconnection of the neutral conductor is required, disconnection and reconnection shall be such that the neutral conductor shall not be disconnected before the line conductors and shall be reconnected at the same time as or before the line conductors.

RCD Recommendation

This equipment contains EMI/EMC filter, which generates a leakage current below 3.5 mA per converter in conformity with UL1778 safety standard. If an RCD device needs to be installed, it should be placed at the AC output of the equipment.

WARNING !!!

Input Neutral is required to operate the Converter, UPS

In TN-S System no 4 pole input switch or circuit breaker shall be used. If you have to use 4 pole protective device, be aware that the neutral against the ground is floating. The converter, UPS will operate without problem but you may infringe the local regulation.

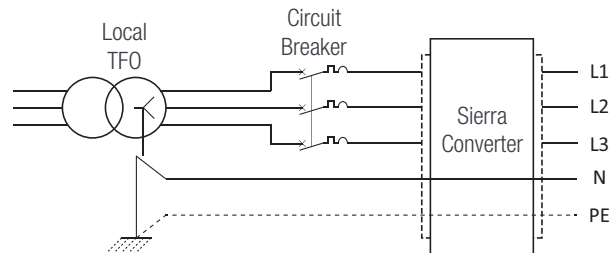

The AC input is wired to a screw terminal.

Max cable area is 180 mm².

10.5.5.1 Single phase

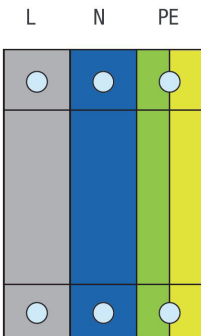

10.5.5.2 Three phase

The three phase input is 123, ABC, RST phase sensitive; clockwise rotation is recommended. Phase one starts at 0° phase shift, while the other phases will be at -120° phase shift and + 120° phase shift resulting in three phase output.

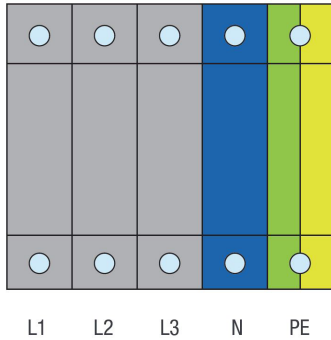

10.5.6 DC (X1)

- Common DC input per system.
- M12 holes in bar.
- Max 8 x 240 mm² per pole (group).

Note: Screws and nuts are not included in the delivery.

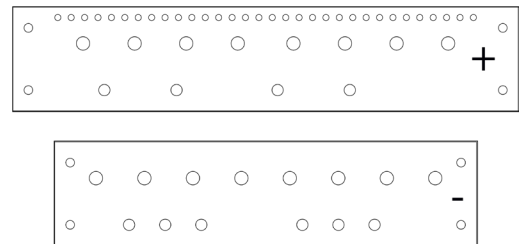

10.5.7 Connection table – DC 48 Vdc (X1)

Power (kVA)		DC			
1ph	3ph	Fuse/CB	Min Cable mm ²		
11	-	250 A	120		
22		500 A	240		
33		800 A	2 x 240		
-	33	1000 A	4 x 150		
44	-			1250 A	3 x 240
55				2 X 800 A	4 x 240
66					
-	66	2 X 1000 A	8 x 150		
77	-				
-	82.5	2 X 1000 A	8 x 150		
88		2 X 1000 A	8 x 150		

10.5.8 Connection table – AC Input (X2) & Output (X4)

The AC input supply breaker shall be 2p for single phase, and minimum 3p for three phase.

Power (kVA)			AC Input & Output (Screw terminal)		
1ph	2ph	3ph	Calculated	Fuse/CB	Min.Cable mm ²
11	-	-	92A	100 A	35
22			183 A	200 A	95
-	22		2 x 92 A + N	100A	2 x 35
33	-	33	275 A	325 A	70
-	-		3 x 92 A + N	3 x 100 A	3 x 35
44	-	-	367 A	400A	180
-	44		2 x 183 A + N	2 x 200 A	2 x 95
55	-		458 A	500 A	95
66			550 A	600 A	150
-	66	-	2 x 275 A + N	2 x 300 A	2 x 150
-	-	66	3 x 183 A + N	3 x 200 A	3 x 95
77	-	82.5	642 A	700 A	180
-	-		3 x 229 A + N	3 x 250 A	3 x 150
88	-	-	733 A	800 A	2 x 180
-	88		2 x 367 A + N	2 x 400 A	3 x 180

10.5.9 Signalling

The illustration below shows the X3 relays contacts in a non-alarm state when the system is operational. In this case, the relays are energized and as below.

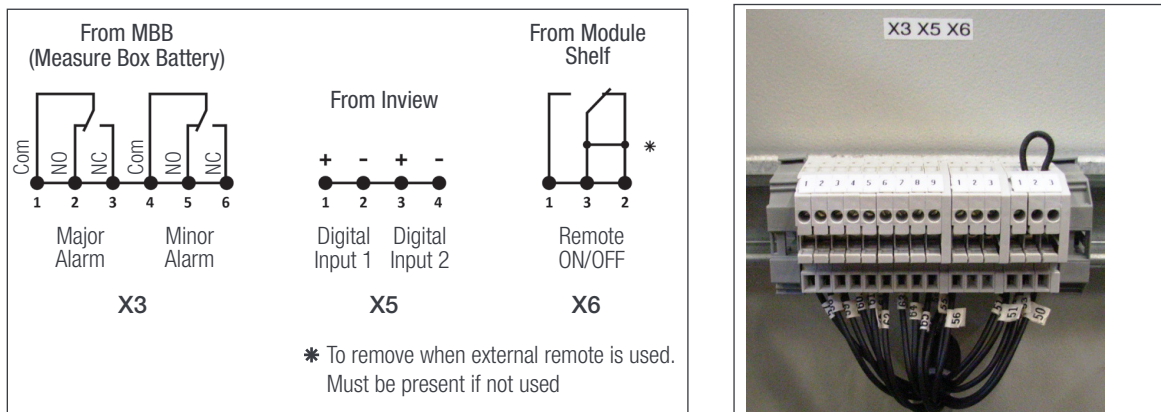

When an alarm occurs, the X3 relay contacts are de-energized and switch.

Note: For auxiliary connections from MBP, refer section 13.2, page 38.

10.5.9.1 Alarm (X3)

Relay characteristics X3 (Major and Minor Alarm)

- Switching power 60 W
- Rating 2 A at 30 Vdc / 1 A at 60 Vdc
- Max wire size 1 mm²

10.5.9.2 Digital Inputs (X5)

Input characteristics X5 (Digital Input 1 and 2)

- Signal voltage +5 Vdc (galvanically insulated)
- Max wire size 1 mm²

10.5.9.3 Remote ON/OFF (X6)

The function of remote ON/OFF is to turn off the system's output.

By default a jumper is placed between pin 3 and 2. If remote on/off is used, jumper should be removed from the shelf and connect changeover contactor.

- AC and DC inputs are not affected by the remote ON/OFF function.
- The remote ON/OFF can be connected to any shelf.
- The remote ON/OFF requires changeover contactor, one input opens as the other close. If both transitions are not picked up the status is not changed.
- Digital input characteristics (Remote ON/OFF)
 - Signal voltage +5 VDC (galvanically insulated)
 - Max wire size 1 mm²

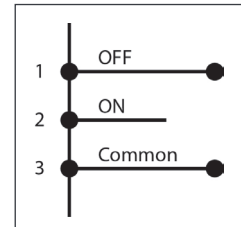

Functional table for remote ON/OFF function

#	Pin 1-3	Pin 2-3	Status	Indication
1	Open	Open	Normal operation	All (Green)
2	Closed	Open	OFF	AC output (OFF) AC Input (Green) DC Input (Green)
3	Open	Closed	Normal operation	All (Green)
4	Closed	Closed	Normal operation	All (Green)

Warning:

If remote ON/OFF not used, pin 2 and 3 MUST be bridged together!

11. Inserting/removing/replacing - modules

11.1 Sierra Converter

- The Sierra converter is hot swappable.
- When a new module is inserted in a live system it automatically takes the working set of parameters.
- When a new module is inserted in a live system it is automatically assigned to the next available address.

Caution: After removing a module from a slot in a live system, wait at least 60 seconds before inserting it into another slot; ensure that the LEDs are off and the fan is completely stopped.

11.1.1 Removal

Caution: When one or several converter modules is/are removed, possible to access the live parts. So, replace the module(s) with dummy modules without delay.

1. Rotate the screw in anti clockwise by using cross head screw driver to unlock the latch.
2. Hold the front handle and pull the module out.
3. Replace with a new module or a blind unit.

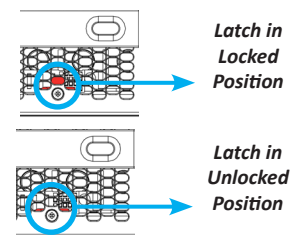
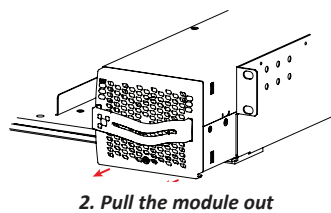
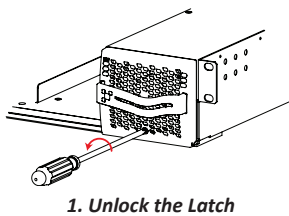

11.1.2 Inserting

1. Check module compatibility (DC Voltage!).
2. Place the module in the shelf and slide in.
3. Using the module handle, push firmly until the unit is properly connected.
4. Rotate the screw in clockwise by using cross head screw driver to lock the latch.
5. The module will start up and take the first address available on the bus.

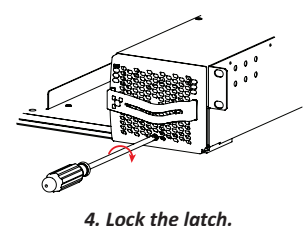
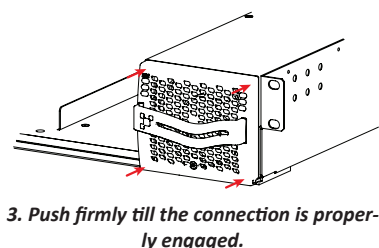
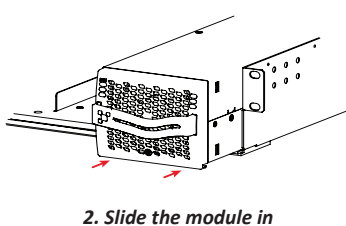

11.2 Fan replacement

The FAN life is approximately 60,000 (Sixty Thousand) hours. The converter modules have fan runtime meters and fan failure alarms. Fan failure can result from a failing fan or driver circuit.



1. Let the module rest at least 5 minutes before initiating work.
2. The converter front cover must be removed. Use a screw driver and remove the screws on both side of the module.
3. Free up the fan. (Note the fan connector and wires position).
4. Disconnect the supply cord, and remove the fan.
5. Replace with new fan and connect supply cord.
6. Place the front cover and tighten the screws on both sides of the module.
7. Check fan for operation.
8. Access Inview and reset the fan run time alarm from within the action menu.



12. AC Output Distribution

12.1 Miniature Circuit breaker Installation/Removal

Circuit breakers are normally factory installed.

How to add breakers:

1. Insert the short connection cable (10 mm² (included)) in the breaker Line-side and tighten.
 - Up to 40 A breaker - use one connection cable.
 - 63 A breaker - use two connection cables.
2. Clip breaker on to the DIN rail.
3. Insert insulated screw driver into the terminal to load the spring.
4. Insert connection cable and remove screw driver.
5. Connect load cable to breaker, Neutral and Ground.
6. Switch breaker ON.

Remove breaker in reverse order

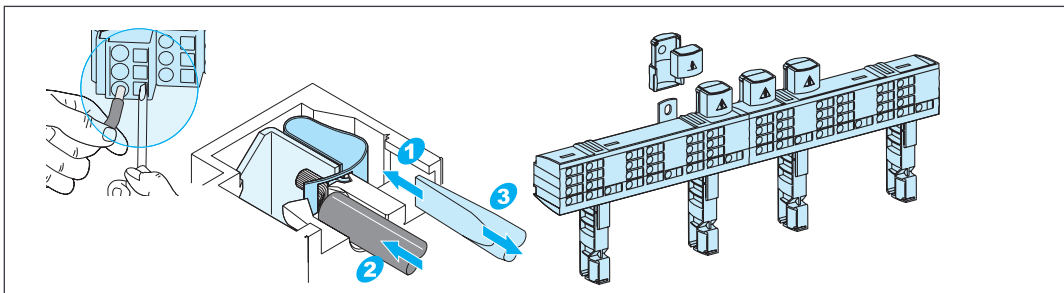

12.2 MCCB

MCCBs are factory installed.

A wide range of breakers is used. Delivered breakers may vary from the example shown in the picture.

1. Make sure that the breaker is in OFF position.
2. Connect load cables to the terminal.
3. Switch the breaker ON.



13. Manual By-Pass (Optional)

Manual By-Pass has to be operated by trained people only.

When system is in manual by-pass the load is subjected to mains voltage without active filtering. Output alarm is activated when system is in manual by-pass.

The Manual By-Pass cannot be operated remotely.

The Manual By-Pass can be integrated into the CE+T cabinet if requested at time of order. A Manual By-Pass purchased separately must comply with the instructions within section 13.2, page 38

13.1 Pre-requisites

Commercial AC power must be present, and the converter must be synchronized with it, before operating MBP. The upstream commercial breaker must be correctly sized to accept the overload, and if the AC is supplied by a Gen-set, the minimal required power will be twice the nominal power of the converter.

The converter may be overloaded during the MBP procedure, depending on voltage network and output. Converter voltage setting: To reduce the impact of an overload, the converter power and current will be reduced from 150% to nominal value.

The by-pass switch disconnects all AC voltage on the shelves but has no effect on the DC feeding the converter and the remote alarm terminal.

It is requested in order to reduce the inrush current during manual by pass operation to adjust the converter AC output voltage to the same value as AC input voltage. If the difference between AC input and AC output voltage exceed 5 Vac, there is a risk of shutdown of converter due to high inrush current during the return to normal operation from Manual By Pass engaged.

13.2 MBP Auxiliary connection

If manual by pass is installed in the system and its auxiliary should be wired as per the following:

- MBP - Single rotary switch

Note: The below connection is for a sub-rack system, and auxiliary (Aux) number varies depending upon the MBP switch. So it is recommended to refer the technical sheet received along with the system.

- Connect Aux3 of MBP to Digital Input 01 of controller. So that the controller gets information when MBP is engaged. The Digital Input Mode must be configured through the Inview web interface. For more details, refer to the Inview User Manual.
- Connect Aux1 and Aux2 of MBP to Remote ON/OFF terminal in the shelf where controller is installed.

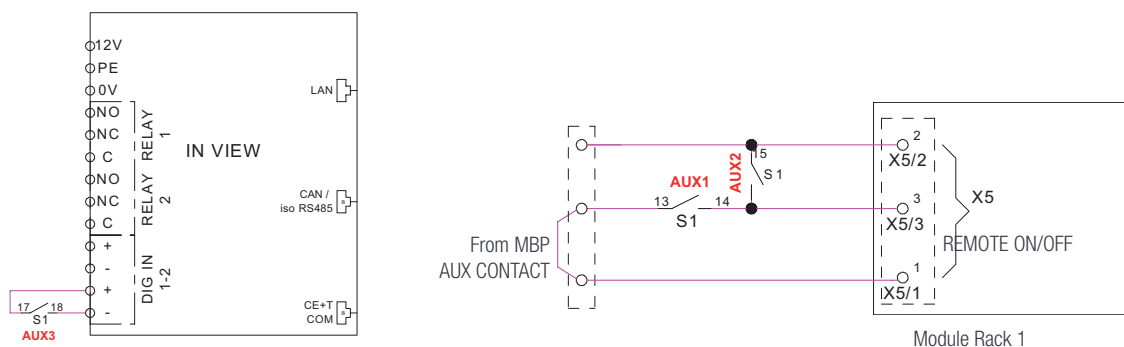

- **MBP - Three independent switch**
 - Connect auxiliary wire from MBP switch (S1) to Digital Input 01 of controller. So that the controller gets information when MBP is engaged. The Digital Input Mode must be configured through the Inview web interface. For more details, refer to the Inview User Manual.
 - Connect auxiliary wire from MBP switch (S1) and AC input switch (S3) to Remote ON/OFF terminal in the shelf where controller is installed.

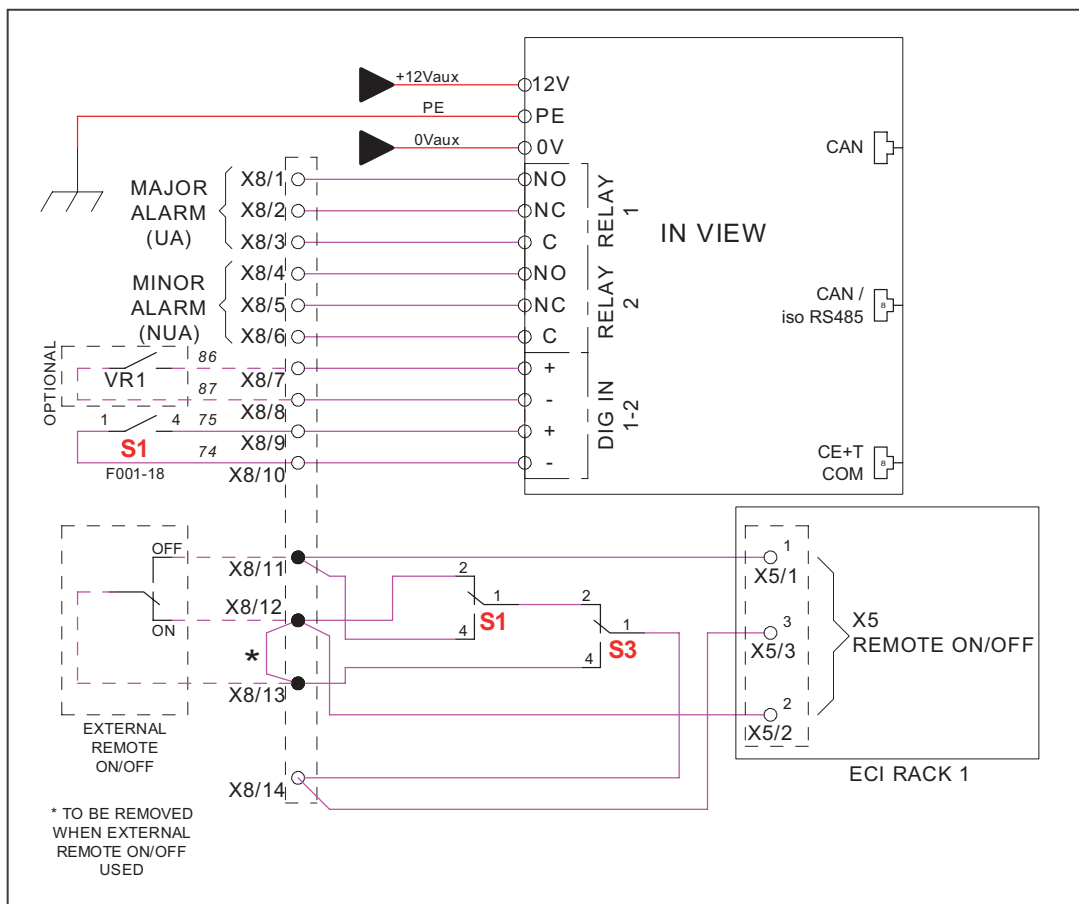

13.3 Manual Bypass operation

Manual Bypass operation creates a bypass from mains input via output AC distribution. Converter modules are bypassed and possible to disconnect without impacting the load.

Manual By-Pass operation is "Make before Break" logic

The sierra system has a single rotary switch or three individual switches depending upon the system configuration, and the operation also varies for each model.

13.3.1 MBP - Single rotary switch

In this model, manual bypass operates in single switch and it has three positions - Normal, Interim and Bypass.

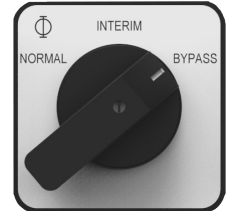

13.3.1.1 Normal to Bypass

1. Rotate the MBP Switch (S1) from **NORMAL** to **BYPASS**. (Note: Do not stop at **INTERIM** position)
2. Switch **OFF** the DC power and/or disconnect batteries.

Manual By-Pass puts the module in the OFF state but does not disconnect the DC. Make sure DC is disconnected before any intervention inside the system.

Warning: Risk of electric shock. Power will be available at AC Input terminal, AC Output terminal, DC Input terminal, and Surge Arresters.

13.3.1.2 By-Pass to Normal

1. Switch **ON** the DC power and/or connect batteries.
2. Rotate the MBP Switch (S1) from **BYPASS** to **INTERIM**.
(Wait until the modules turn on and synchronized, approximately 30-60 seconds).
3. Rotate the MBP Switch (S1) from **INTERIM** to **NORMAL**.

Warning: If ATS (Automatic Transfer Switch) is installed upstream to select AC source. Make sure that the ATS switch does not allow transfer between AC source out of sync. The maximum allowed phase shift is 10°.

13.3.2 MBP - Three individual switches

In this model, manual bypass operates through three individual switches - S1 (Manual Bypass), S2 (AC out) and S3 (AC IN).

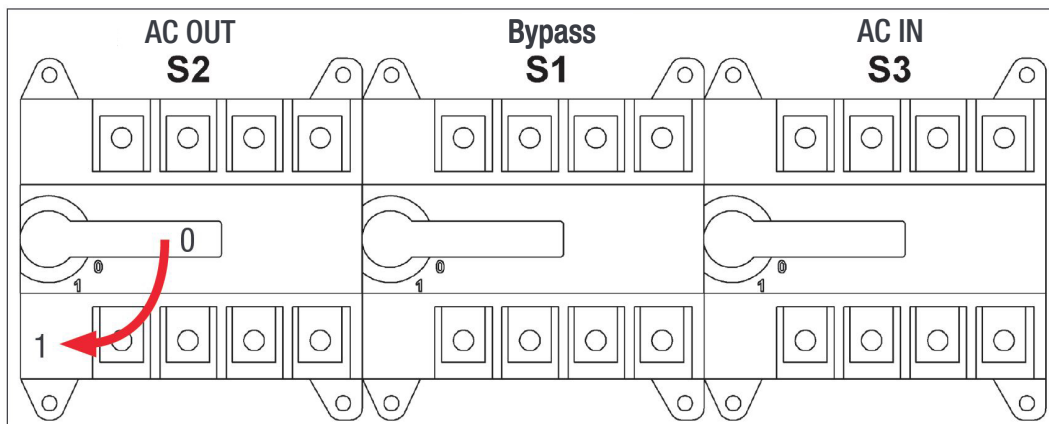

13.3.2.1 Normal to By-Pass

1. Close the By-Pass switch **S1**, 0 to 1
2. Open the AC Out switch **S2**, 1 to 0
3. Open the AC IN switch **S3**, 1 to 0
4. Switch **OFF** the DC power and/or disconnect batteries

13.3.2.2 By-Pass to Normal

1. Switch **ON** the DC power and/or connect batteries.
2. Close the AC IN switch **S3**, 0 to 1
(Wait until the modules turn on and synchronized, approximately 30-60 seconds).
3. Close the AC Out switch **S2**, 0 to 1
4. Open the By-Pass switch **S1**, 1 to 0

14. Finishing

- Make sure that the sub-rack/cabinet is properly fixed to the cabinet/floor.
- Make sure that the sub-rack/cabinet is connected to Ground.
- Make sure that all DC and AC input breakers are switched OFF.
- Make sure that all cables are according to recommendations and local regulations.
- Make sure that all cables are strained relieved.
- Make sure that all breakers are according to recommendation and local regulations.
- Make sure that DC polarity is according to marking.
- Re tighten all electrical terminations.
- Make sure that no converter/controller positions are left open.
- Cover empty converter positions with blanks.
- Make sure that the Remote ON/OFF is appropriately wired according to local regulations.
- Make sure that the point of AC supply meets local regulations.

15. Commissioning

The DC breaker is a protection device. Modules are plugged in a system and DC breaker is then engaged. Please make sure the corresponding DC breaker is engaged in the ON position. Failure to observe this rules will result not to have all module operating when running on DC and have module failure when AC input recover from fault condition.

Installation and commissioning must be done and conducted by trained people fully authorized to act on installation.

It is prohibited to perform any isolation test without instruction from manufacturer.

Equipments are not covered by warranty if procedures are not respected.

15.1 Check list

DATA	
Date	
Performed by	
Site	
System serial number	
Module serial numbers	
Inview Serial number	
ACTION	OK/ N.OK
Unplug all converters except one converter per phase (Just pull off the inverter from the shelf, to interrupt electrical contacts)	
Check the commercial AC before closing the AC input breaker.	
Switch ON the commercial AC	
Check if converters are working (Green led)	
Check the DC power supply and switch ON the DC breakers	
Plug in all converters one by one	
Check output voltage (on bulk output or on breaker)	
Check if converters are working properly	
Check if system has no alarm (Disable the alarm if any)	
Read configuration file and review all parameters. Some parameters must be adapted according to the site (LVD, load on AC, AC threshold level)	
Switch OFF ACin and check if system is working on DC	
Switch ON ACin and check if system correctly transferred load on AC	
Switch OFF system and start on AC only	
Switch OFF system and start on DC only	
Check if display working properly (Inview)	
Check if TCPIP working properly (if this option is present)	
Test on load (if available)	
ALARM	
Switch ON AC input and DC input and check that no alarm are present	
Pull out one converter and check alarm according to redundancy	
Pull out two converters and check alarm according to redundancy	
Switch OFF AC input (commercial power failure) and check the alarm according to the configuration	
Switch OFF DC input (DC power failure) and check that the alarm according to the configuration	
Check the different digital input according to the configuration (when used)	

16. Trouble Shooting and Defective Situations Fixing

16.1 Trouble Shooting

Converter module does not power up:	<ul style="list-style-type: none"> Check AC input present and in range (AC breakers) Check DC input present and in range (DC breakers) Check that the converter is properly inserted Remove converter to verify that slot is not damaged, check connectors Check that module(s) is (are) in OFF state Check for loose terminations
Converter system does not start:	<ul style="list-style-type: none"> Check that Inview is present and properly connected Check remote ON/OFF terminal Check the configuration and setting Check threshold level
Converter only run on AC or DC:	<ul style="list-style-type: none"> Check AC input present and in range (AC breakers) Check DC input present and in range (DC breakers) Check the configuration and setting Check threshold level(s)
No output power:	<ul style="list-style-type: none"> Check output breaker
All OK but I have alarm:	<ul style="list-style-type: none"> Check the type of event and log file in the controller
No alarm:	<ul style="list-style-type: none"> Check relay delay time of alarms in the controller Check configuration file

16.2 Defective modules

- A repair request should follow the regular logistics chain:
End-user => Distributor => CE+T Power.
- Before returning a defective product, a RMA number must be requested through the <http://my.cet-power.com> extranet. Repair registering guidelines may be requested by email at repair@cet-power.com.
- The RMA number should be mentioned on all shipping documents related to the repair.
- Be aware that products shipped back to CE+T Power without being registered first will not be treated with high priority!

17. Maintenance

Maintenance should be performed by properly trained people.

17.1 Access Inview with Laptop

- Download system LOG FILE and save
 - Analyze log file and correct errors
- Download system CONFIGURATION FILE and save
 - Check/correct configuration file according to operation conditions
 - Check/correct alarm configuration
- Check module internal temperature for deviation between modules
 - Temperature deviation may indicate build up of dust. Clean the module by air suction blower or vacuum cleaner.
- Check module/system load
- Check/Correct inverter mapping (DC group/AC group/ Address)

17.2 Manual check

- Check voltages of AC input, DC input, AC output and DC output using the multi-meter
- Replace door filter if more dust is accumulated.
- Take a snap shot of the cabinet and site condition

17.3 Optional

- With an infrared camera check termination hot spots
 - Tighten terminations

17.4 Manual By-Pass

- Make sure AC input source is available during MBP operation. Otherwise the LOAD will be affected.

18. Service

For Service

- Check Service Level Agreement (SLA) of your vendor. Most of the time they provide assistance on call with integrated service. If such SLA is in place, you must call their assistance first.
- If your vendor doesn't provide such assistance (*) you may contact CE+T through email:
 - USA and Canada: tech.support@cetamerica.com
 - Rest of the world: customer.support@cet-power.com

(*) CE+T will redirect your call to your vendor if he has such SLA in place.

19. Appendix

19.1 Mains connection, Single phase

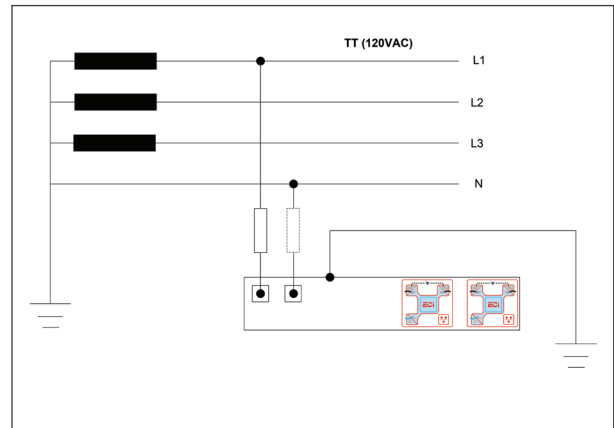
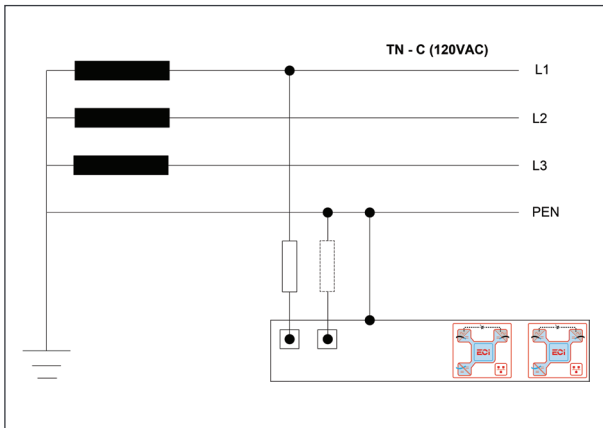
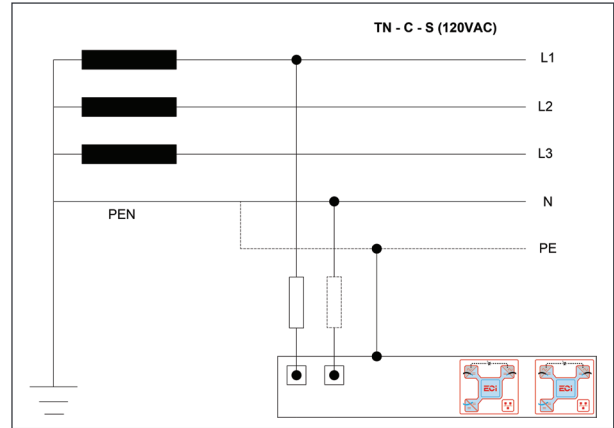
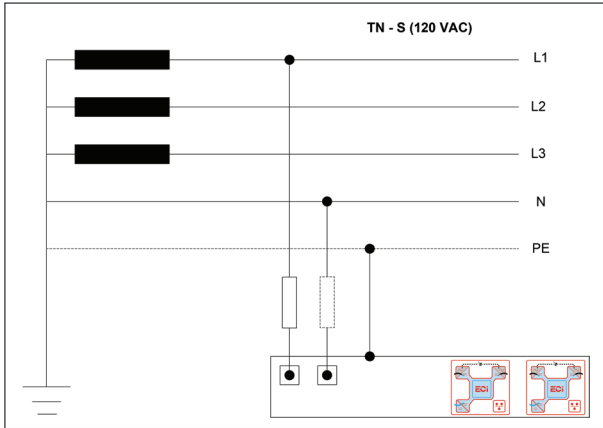

19.2 Mains connection, Three phases

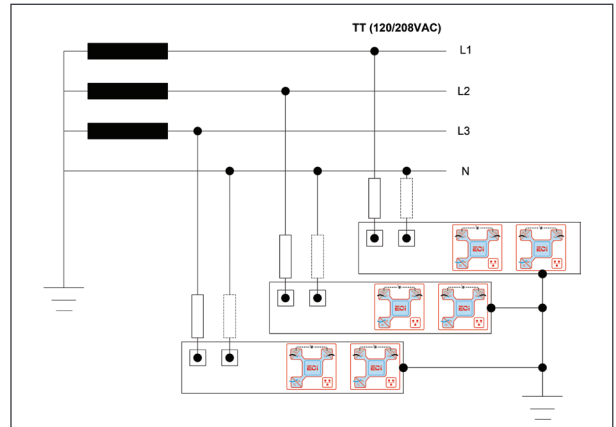
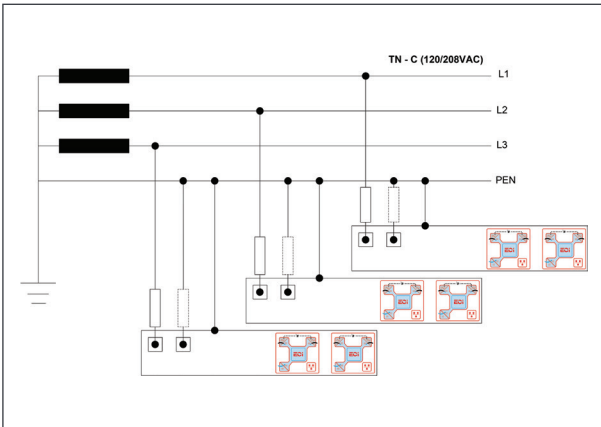
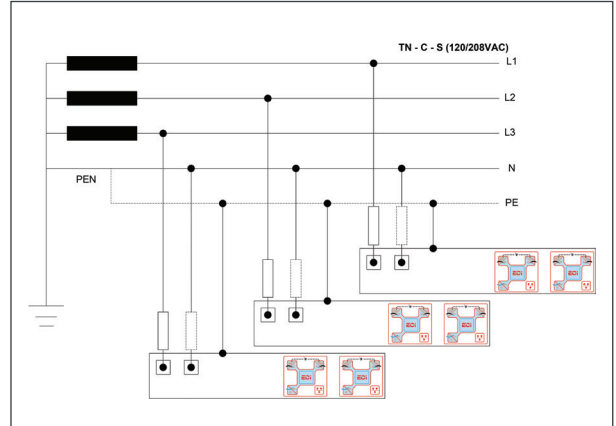
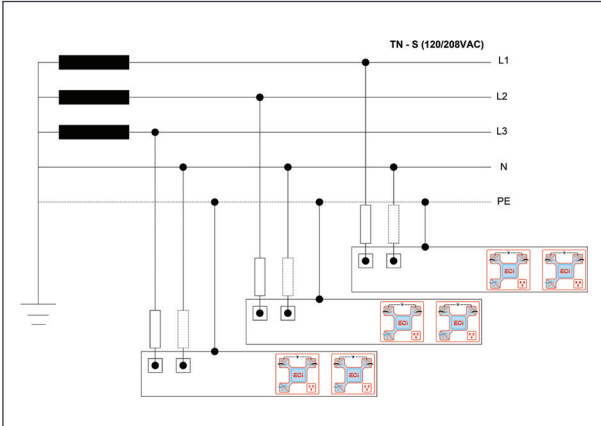

19.3 Sierra 25 - Dimensions

19.3.1 Module

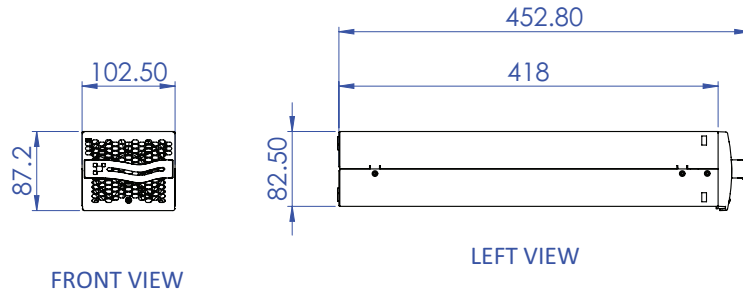

19.3.2 Shelf

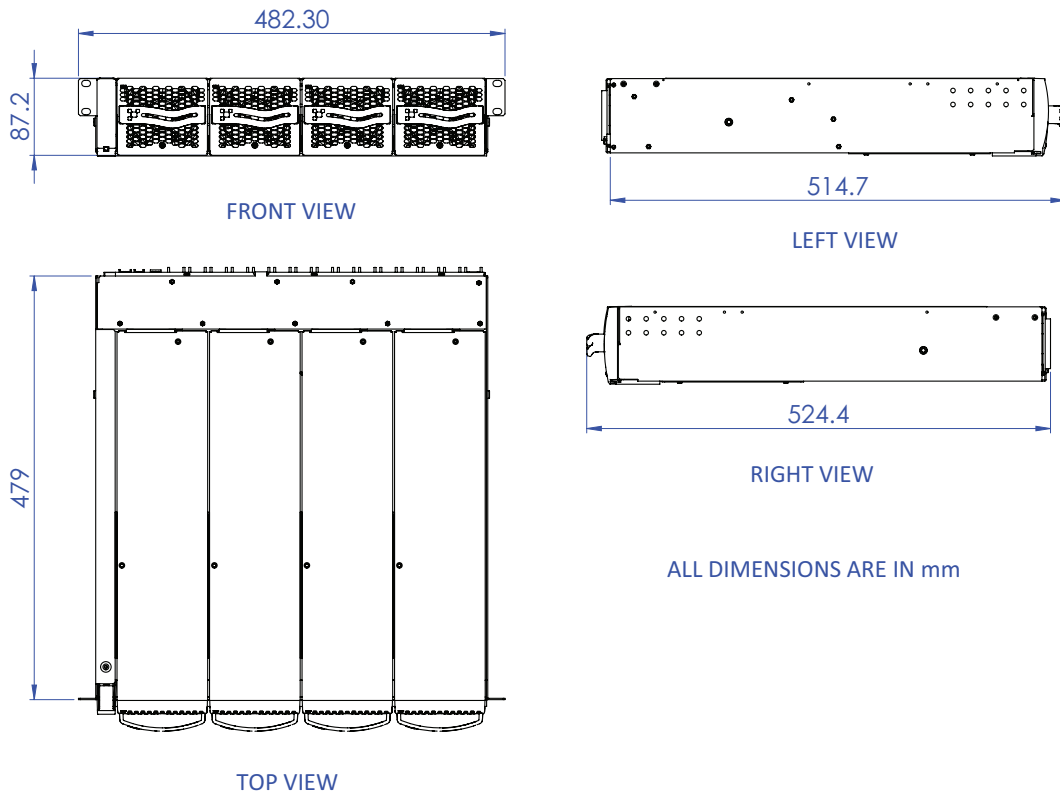

19.4 Modules - Parameter List

With Inview, you can access the modules' parameter list and descriptions. Refer to the Inview and Inview GW user manuals to access the Inview web interface.

Inview S and X - <https://datasheet.cet-power.com/CET - Monitoring - User Manual - Inview - EN.pdf>

Inview GW - <https://datasheet.cet-power.com/CET - Monitoring - User Manual - Inview GW - EN.pdf>

If you want to have an overview of standard systems' parameters, you can also view the parameters in our Monitoring Emulator - <https://www.cet-power.com/en/monitoring-emulator/>.

Do not hesitate to use the help buttons to get more information about the parameters.

